



**CLAVOS NACIONALES**  
CONQUISTANDO EL FUTURO

## TUERCAS AUTOMOTRICES

### MANGO

Código	Descripción	Medida hexágono A x B	Aplicación	Precio x pieza	Empaque
100402795	CN-105R 3/4-16	1 1/8" x 17/32"	Ford	34.86	100
100402805	CN-107R 3/4-16	1 1/16" x 33/64"	General Motor	29.93	150
100402815	CN-109R 7/8-14	1 1/4" x 7/8"	Ford	50.71	100

#### CN-105R

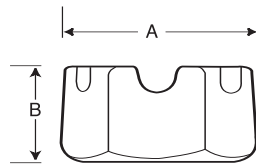

#### CN-107R

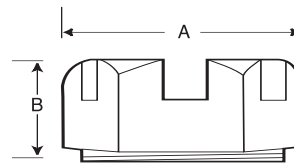

#### CN-109R

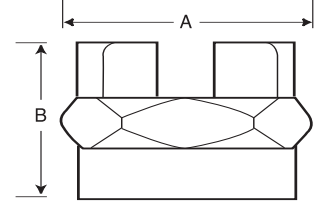

### CONO PARA BIRLO DE FLECHA

Código	Descripción	Diámetro del cono	Precio x pieza	Empaque
100403035	CN-144	7/16" int x 3/4" ext	9.66	700
100403040	CN-145	1/2" int x 13/16" ext	12.23	600
100403045	CN-146	9/16" int x 7/8" ext	17.75	500
100403050	CN-147	5/8" int x 1" ext	19.82	400
100403055	CN-148	3/4" int x 1 1/8" ext	27.61	300

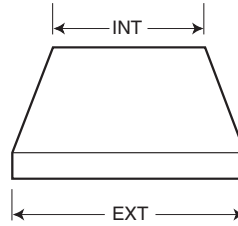

### FLECHA LATERAL

Código	Descripción	Medida hexágono A x B	Aplicación	Precio x pieza	Empaque
100402835	CN-115R M24X1.5	36.5 X 16.6 mm	Volkswagen	110.14	75

#### CN-115R

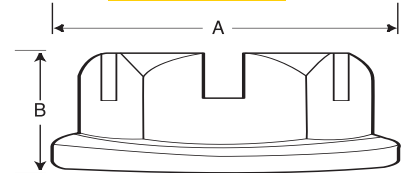

### ARTILLERÍA

Código	Descripción	Medida hexágono A x B	Precio x pieza	Empaque
100402655	CN-26R 5/8-11	1 1/16" x 5/8"	22.10	200
100402660	CN-34R 3/4-10	1 1/4" x 3/4"	44.46	100

#### CN-26R

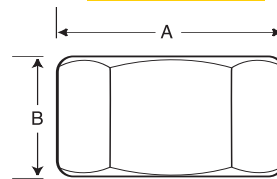

#### CN-34R

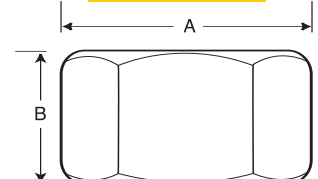

## VÁLVULAS DE ESFERA Ó BOLA



**CLAVOS NACIONALES**  
CONQUISTANDO EL FUTURO

## VÁLVULAS DE BRONCE CROMADO

### ROSCADAS

Código	Longitud		Precio x pieza
	pulg	mm	
118020210	1/4"	6.3	139.25
118020220	3/8"	9.5	139.25
118020230	1/2"	12.7	225.38
118020240	3/4"	19.0	328.74
118020250	1"	25.4	479.47
118020260	1 1/4"	31.8	769.45
118020270	1 1/2"	38.1	1,065.17
118020280	2"	50.8	1,754.23





**CLAVOS NACIONALES**  
CONQUISTANDO EL FUTURO

## VÁLVULAS DE BRONCE CROMADO

### ROSCADAS

Código	Longitud	
	pulg	mm
118020290	2 1/2"	63.5
118020300	3"	76.2
118020310	4"	101.6



Diámetro	A	B	h
1/4"	41	68	40
3/8"	41	68	40
1/2"	50	98	48
3/4"	57	98	51
1"	66	110	56
1 1/4"	75	134	77
1 1/2"	90	134	80
2"	100	160	90
2 1/2"	143	232	114
3"	165	232	122
4"	190	260	140

### DENOMINACIÓN

### MATERIAL

1.- CUERPO	BRONCE
2.- RACOR	BRONCE
3.- PRENSA-ESTOPAS	BRONCE
4.- MANETA	ACERO
5.- ARANDELA	BRONCE
6.- EJE	BRONCE
7.- TUERCA	ACERO
8.- JUNTAS CIERRE	PTFE
9.- BOLA	LATON
10.- JUNTA EJE	PTFE
11.- FUNDA MANETA	CAUCHO VIRGEN

### SOLDABLES

Código	Longitud	
	pulg	mm
118020410	1/2"	12.7
118020420	3/4"	19.0
118020430	1"	25.4

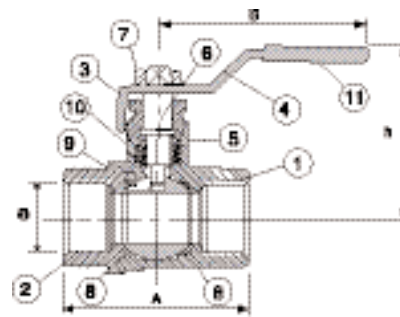
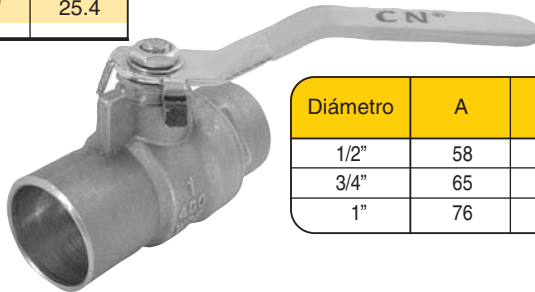

Diámetro	A	B	h
1/2"	58	96	50
3/4"	65	85	45
1"	76	100	64

### DENOMINACIÓN

### MATERIAL

1.- CUERPO	BRONCE
2.- RACOR	BRONCE
3.- PRENSA-ESTOPAS	BRONCE
4.- MANETA	ACERO
5.- ARANDELA	BRONCE
6.- EJE	BRONCE
7.- TUERCA	ACERO
8.- JUNTAS CIERRE	PTFE
9.- BOLA	LATON
10.- JUNTA EJE	PTFE
11.- FUNDA MANETA	CAUCHO VIRGEN



**CLAVOS NACIONALES**  
CONQUISTANDO EL FUTURO

## VÁLVULAS PVC

### ROSCADAS

Código	Longitud	
	pulg	mm
118020510	1/2"	12.7
118020520	3/4"	19.0
118020530	1"	25.4
118020540	1 1/4"	31.8
118020550	1 1/2"	38.1
118020560	2"	50.8

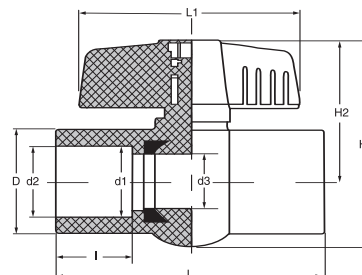

Diámetro	d1	d2	d3	D	L	L1	H1	H2	I
1/2"	ø 21.4	ø 21.8	ø 15	ø 31	70	75	63.5	43.5	22.5
3/4"	ø 26.3	ø 27.1	ø 20	ø 37	90.5	87	76.5	52	25.5
1"	ø 32.9	ø 33.8	ø 24	ø 45	102.5	98.5	93	55	28
1 1/4"	ø 42.2	ø 42.4	ø 30	ø 55	113	108	103	69	28.5
1 1/2"	ø 48.4	ø 48.6	ø 34	ø 52	128.5	108	111.5	63	36.5
2"	ø 60.2	ø 50.6	ø 45	ø 75	148.5	138	127.5	81	40



**CLAVOS NACIONALES**  
CONQUISTANDO EL FUTURO

## VÁLVULAS PVC



CEMENTAR		
Código	Longitud	
	pulg	mm
118020610	1/2"	12.7
118020620	3/4"	19.0
118020630	1"	25.4
118020640	1 1/4"	31.8
118020650	1 1/2"	38.1
118020660	2"	50.8

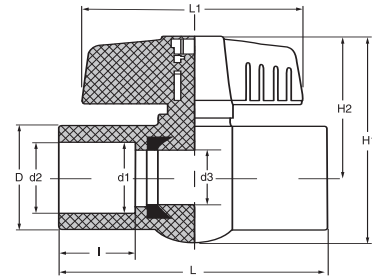

Diámetro	d1	d2	d3	D	L	L1	H1	H2	I
1/2"	ø 21.4	ø 21.8	ø 15	ø 31	70	75	63.5	43.5	22.5
3/4"	ø 26.3	ø 27.1	ø 20	ø 37	90.5	87	76.5	52	25.5
1"	ø 32.9	ø 33.8	ø 24	ø 45	102.5	98.5	93	55	28
1 1/4"	ø 42.2	ø 42.4	ø 30	ø 55	113	108	103	69	28.5
1 1/2"	ø 48.4	ø 48.6	ø 34	ø 52	128.5	108	111.5	63	36.5
2"	ø 60.2	ø 50.6	ø 45	ø 75	148.5	138	127.5	81	40

## VARILLAS



**CLAVOS NACIONALES**  
CONQUISTANDO EL FUTURO

## VARILLA MÉTRICA

**DIMENSIONES:** 1F1 - 136  
**ESPECIFICACIÓN:** SAE J-429 - Grado 2  
**MATERIAL:** Acero bajo carbono  
**DUREZA ROCKWELL B:** 70 mín - 100 máx  
**ROSCADO:** UNC, con ajuste 2 A  
**ACABADO:** • Sin acabado

MÉTRICA SIN ACABADO	
Código	Longitud metro
174019080	M6 x 1.00
174019085	M8 x 1.00
174019090	M10 x 1.00
174019095	M12 x 1.00
174019100	M14 x 1.00
174019105	M16 x 1.00
174019110	M20 x 1.00
174019115	M24 x 1.00



**CLAVOS NACIONALES**  
CONQUISTANDO EL FUTURO

## VARILLA ROSCADA

3/16" (4.7 mm) SIN ACABADO	
Código	Longitud metro
174080118	1.20
174080055	1.00
174080254	2.00
174080299	3.05
174080344	3.66

1/4" (6.3 mm) SIN ACABADO	
Código	Longitud metro
174080010	0.91
174080060	1.00
174080120	1.20
174080210	1.83
174080255	2.00
174080300	3.05
174080345	3.66

5/16" (7.9 mm) SIN ACABADO	
Código	Longitud metro
174080015	0.91
174080065	1.00
174080125	1.20
174080215	1.83
174080260	2.00
174080305	3.05
174080350	3.66

3/8" (9.5 mm) SIN ACABADO	
Código	Longitud metro
174070990	0.61
174080020	0.91
174080070	1.00
174080130	1.20
174080220	1.83
174080265	2.00
174080310	3.05
174080355	3.66